

MEVCUT VANTILATOR
38000m³/h-45kw-250mmSS

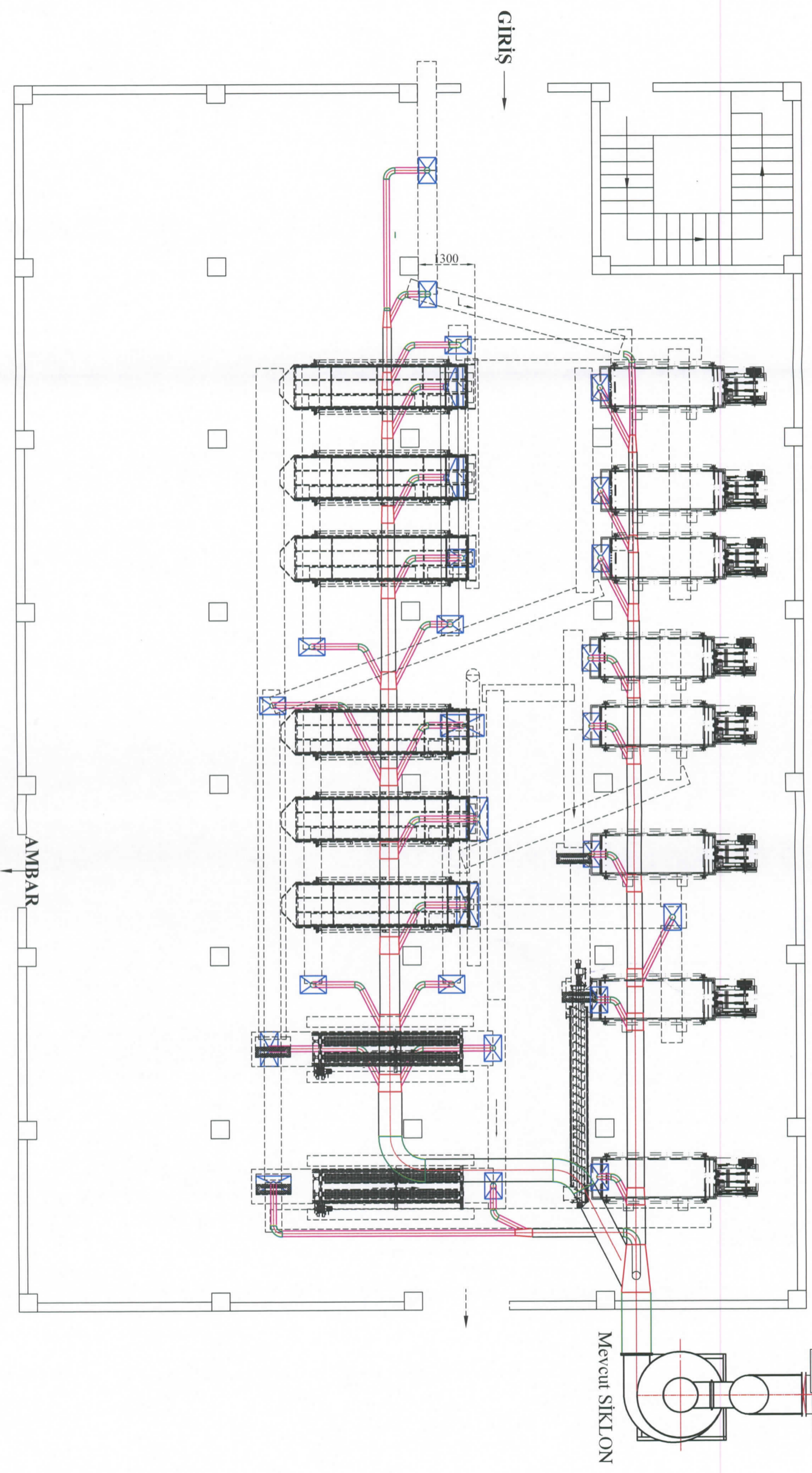

Çizen	Tarih	Ad Soyad	İmza	Onay
Mak.Et.P Şb.Md		Selami COŞKUN		
Makina Şb.Müd		Orhan YAVUZ		
Ölçek	Parça Adı :	Selahattin EYÜBOĞİLU		
Agrılık	AMBARLIK ÇAY FABRİKASI			
İmalat Adeti	TASNİF TOZ EMME SİSTEM YERLEŞİMİ			
	Malzeme	Bayram SEKMEN Makina Daire Başkanı		
	Resim No	2018-1		
	Ürün Kodu			

MEVCUT VANTILATÖR
38000m³/h-45kw-250mmSS

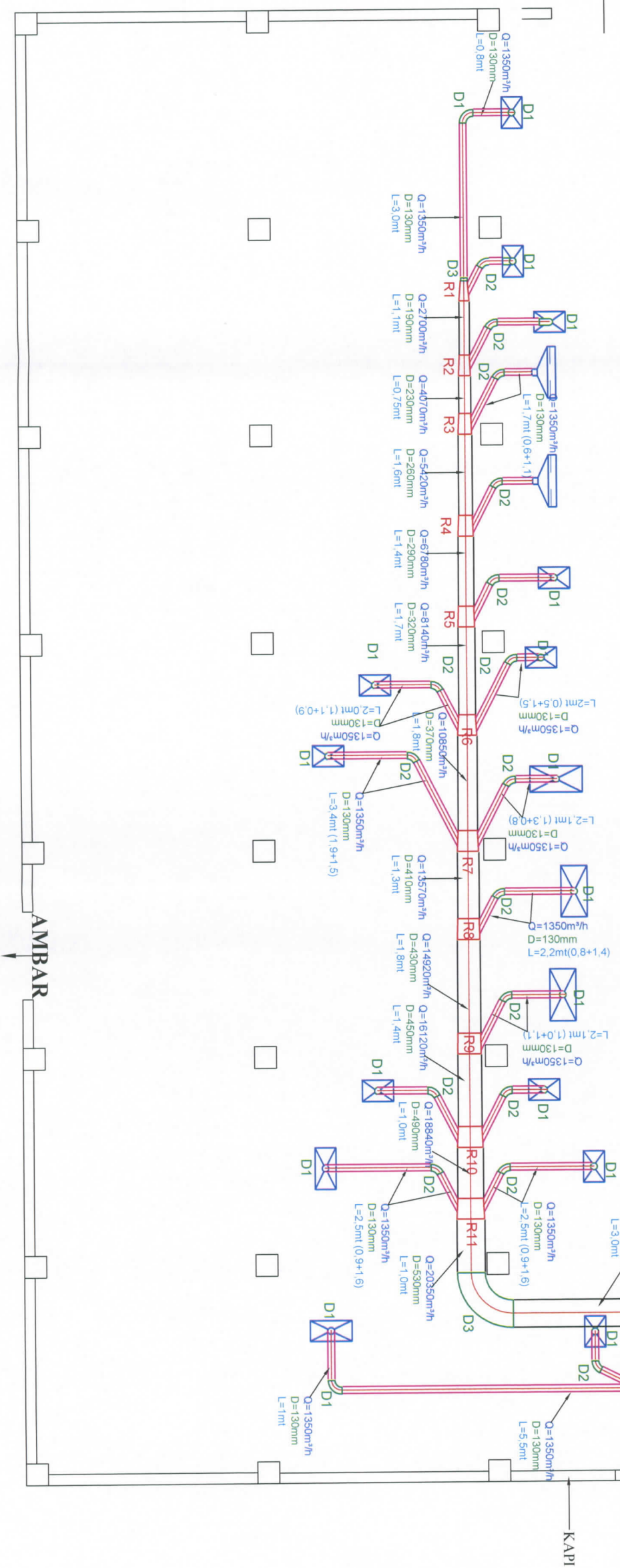
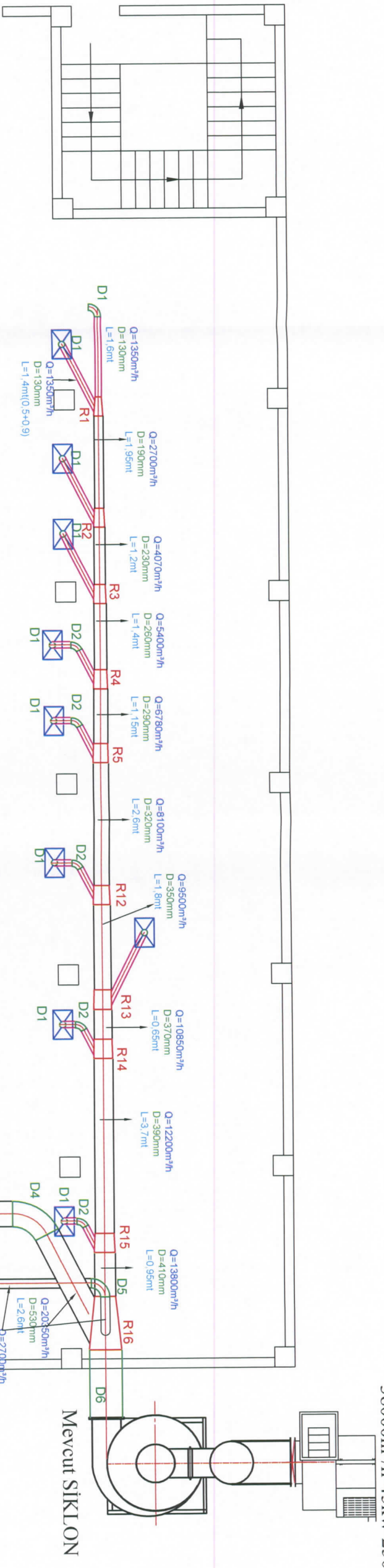

Çizen		Tarih	Ad Soyad	İmza	Onay
Mak. Et.P. Şö.Md.			Selami COŞKUN		
Makina Şö.Müd.			Orhan YAVUZ		
Makina Şö.Müd.			Selahattin EYÜBOĞLU		
Malzeme		Parça Adı :		Resim No	
2018-2					
Ürün Kodu					

AMBARLIK ÇAY FABRİKASI
TASNİF TOZ EMME SİSTEM YERLEŞİMİ

Bayram SEKMEN
Makina Daire Başkanı

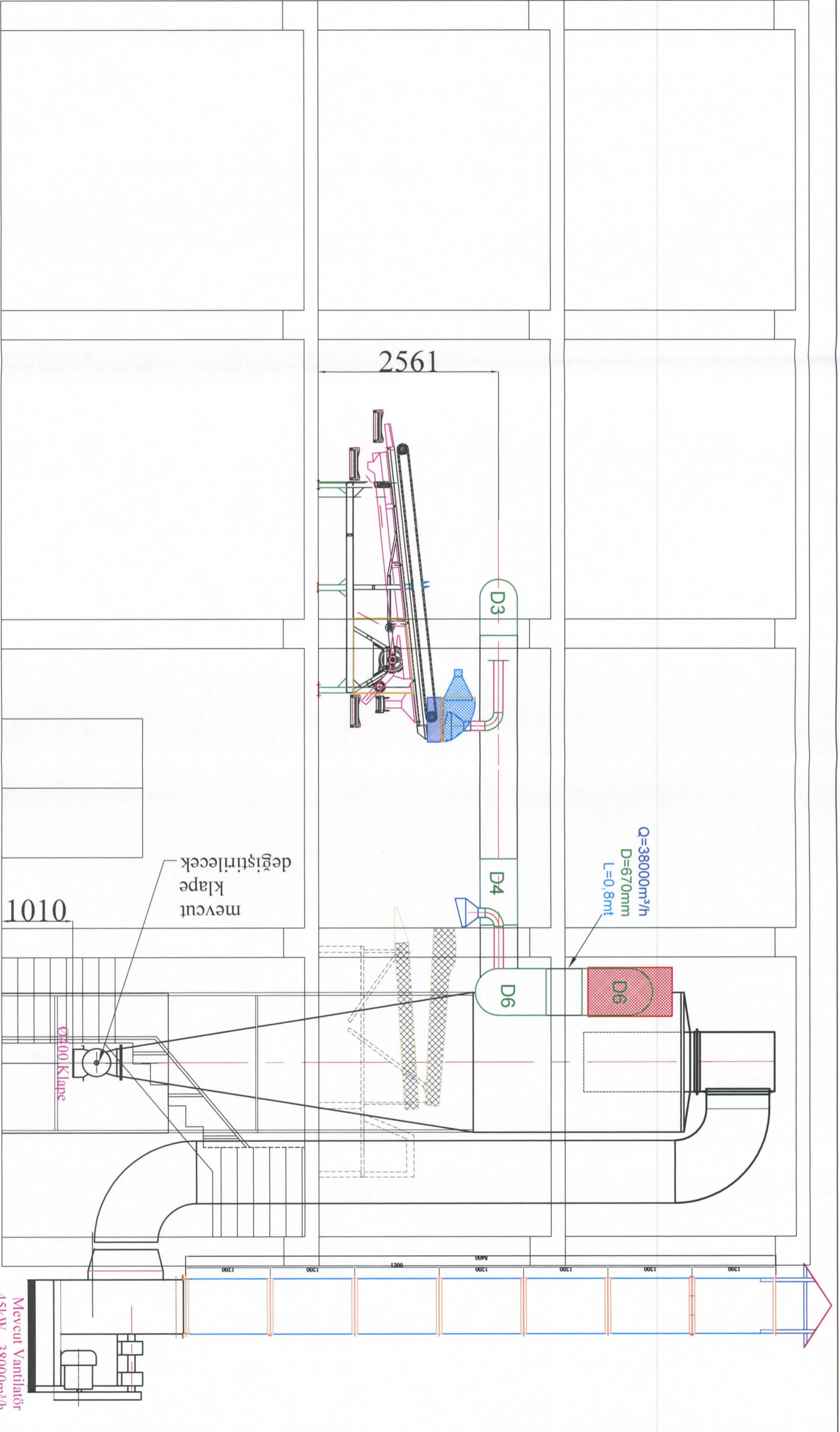

Mevcut SIKLON

Mevcut Vanilatör
45kW - 38000m³/h
250mmss

1010

mevcut
klape
deđiřtirilecek

Q=38000m³/h
D=670mm
L=0,8mt

2561

Çizen	Tarih	Ad Soyad	İmza	Onay
Mak. Et. P. Şp. Md.		Selami COŞKUN	<i>Selami Coşkun</i>	 Bayram SEKMEN Makina Daire Başkanı
Makina Şp. Müd.		Orhan YAVUZ	<i>Orhan Yavuz</i>	
Ölçek	Parça Adı :			
Ağırlık	AMBARLIK ÇAY FABRİKASI			
İmalat Adeti	TASNİF TOZ EMME KESİTİ			
	Malzeme	Resim No		
		2018-5		
	Ürün Kodu			

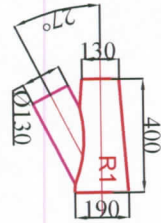

İmalat:2adet

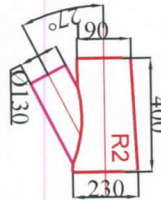

İmalat:2adet

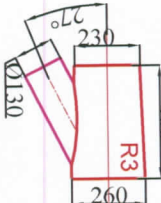

İmalat:2adet

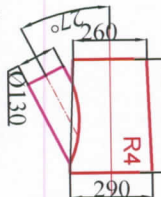

İmalat:2adet

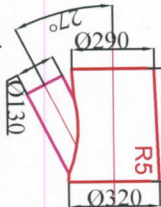

İmalat:2adet

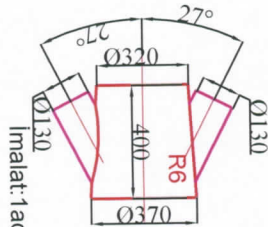

İmalat:1adet

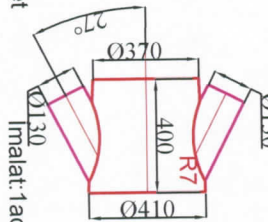

İmalat:1adet

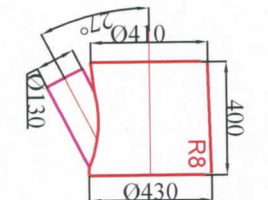

İmalat:1adet

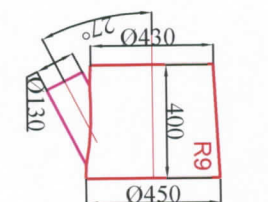

İmalat:1adet

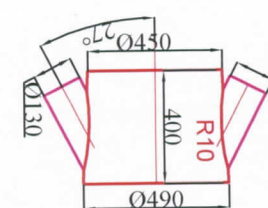

İmalat:1adet

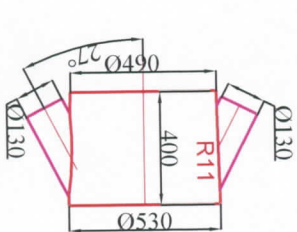

İmalat:1adet

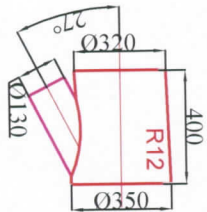

İmalat:1adet

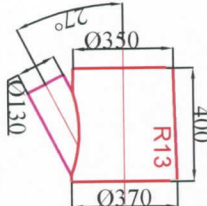

İmalat:1adet

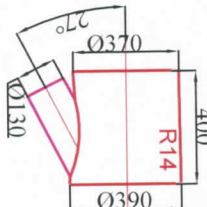

İmalat:1adet

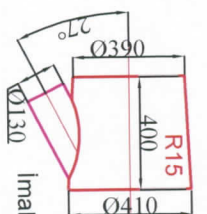

İmalat:1adet

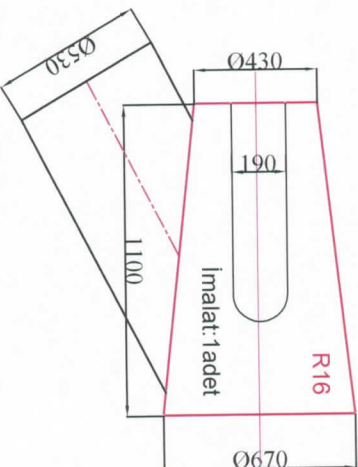

DKP SAC KALINLIĞI:2MM

Tarih	Ad Soyad	İmza	Onay
	Selami COŞKUN		
Çizen			
Mak.EL.P.Şb.Md	Orhan YAUVUZ		Bayram SEKMEN
Makina Şb.Müd	Selahattin EYÜBOĞLU		Makina Daire Başkanı
Ölçek	Parça Adı :		Malzeme
Ağırlık			Resim No
İmalat Adeti			2018-6





AMBARLIK ÇAY FABRİKASI
TASNİF TOZ REDÜKSİYON İMALATI

Ürün Kodu

boru çapı(Q)	uzunluk(L)(m)
900mm	6,20m
670mm	3,40m
530mm	7,40m
510mm	4,70m
470mm	3,00m
430mm	4,50m
410mm	3,50m
390mm	6,00m
370mm	5,00m
350mm	2,50m
320mm	3,50m
290mm	2,60m
260mm	3,50m
230mm	1,90m
190mm	6,20m
130mm	80,0m

Dirsek	Derece	çap(Ø)	Miktar
D1	90°	130mm	27Adet
D2	63°	130mm	20 Adet
D3	90°	530mm	1 Adet
D4	63°	530mm	1 Adet
D5	90°	190mm	1 Adet
D6	90°	670mm	2 Adet

NOT:Ø130"luk DKP BORULARIN SAC KALINLIĞI:1,5mm
Ø130 ÜSTÜ BORULAR İÇİN DKP SAC KALINLIĞI:2,0mm

Tarih	Ad Soyad	İmza	Onay
	Selami COŞKUN		
Çizen	Orhan YAVUZ		Bayram SEKMEN
Mak.Et.P.Şb.Md.	Selahattin EYÜBOĞLU		Makina Daire Başkanı
Makina Şb.Müd.			
Ölçek	Parça Adı :		Malzeme
Ağırlık			Resim No
İmalat Adeti			

AMBARLIK ÇAY FABRİKASI
TASNİF TOZ BORU ve DİRSEK İMALATI

Ürün Kodu

2018-7



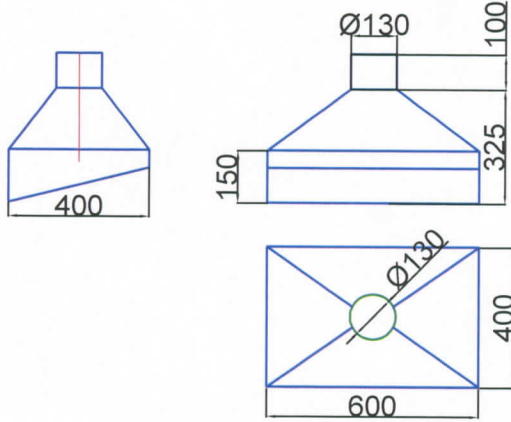

Bant aktarma Davlumbazı
imalat:10 adet

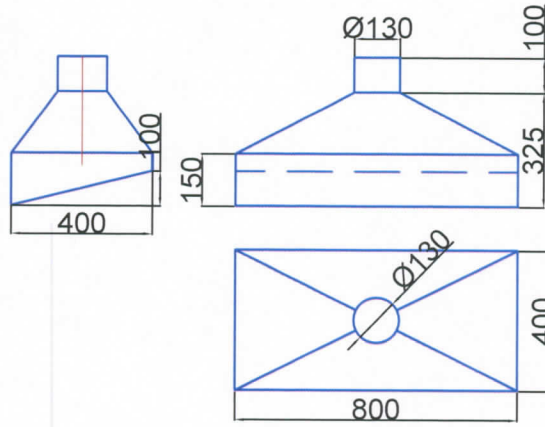

Lif alıcı Kırıcı Davlumbazı
imalat:2 adet

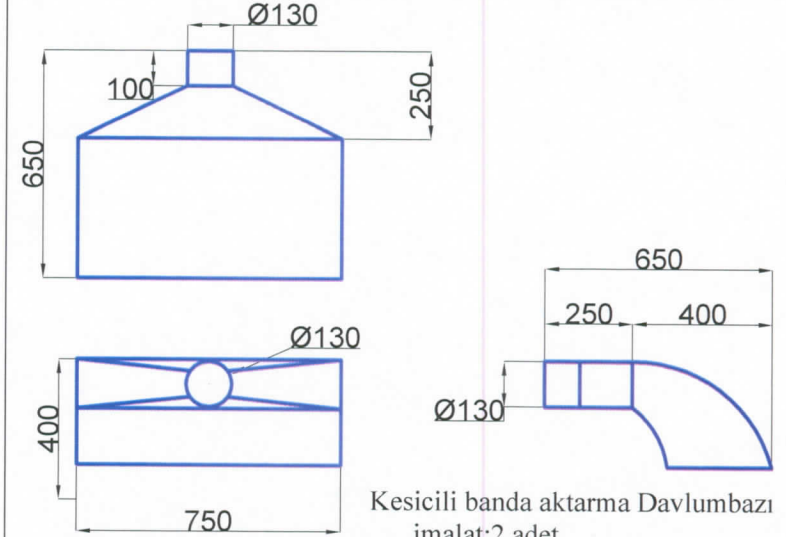

Kesicili bant aktarma Davlumbazı
imalat:2 adet

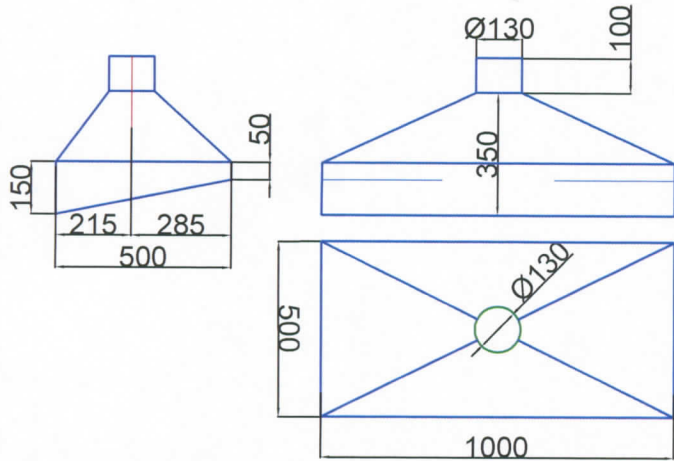

Midilton ve Pakka Davlumbazı
imalat:14 adet

NOT:DAVLUMBAZLAR 304 KROM
SACDAN İMAL EDİLECEK.

	Tarih	Ad Soyad	İmza	Onay
Çizen		Selami COŞKUN		
Mak. Et.P. Şb.Md.		Orhan YAVUZ		Bayram SEKMEN Makina Daire Başkanı
Makina Şb.Müd.		Selahattin EYÜBOĞLU		
Ölçek	Parça Adı :			Malzeme
Ağırlık	AMBARLIK ÇAY FABRİKASI TASNİF TOZ DAVLUMBAZ İMALATI			Resim No
İmalat Adeti				Ürün Kodu

