

	Tarih	İsim	İmza	
Çizen		Selami COŞKUN		 Bayram SEKMEN Makina Dairesi Başkanı
Etüt Prj.Md.		Orhan YAVUZ		
Makina Müd. Miz. Pln. Müd.		S. EYÜBOĞLU		
ÖLÇEK	KENDİRLİ ÇAY FABRİKASI ELEK KESİT GÖRÜNÜŞÜ			Resim no

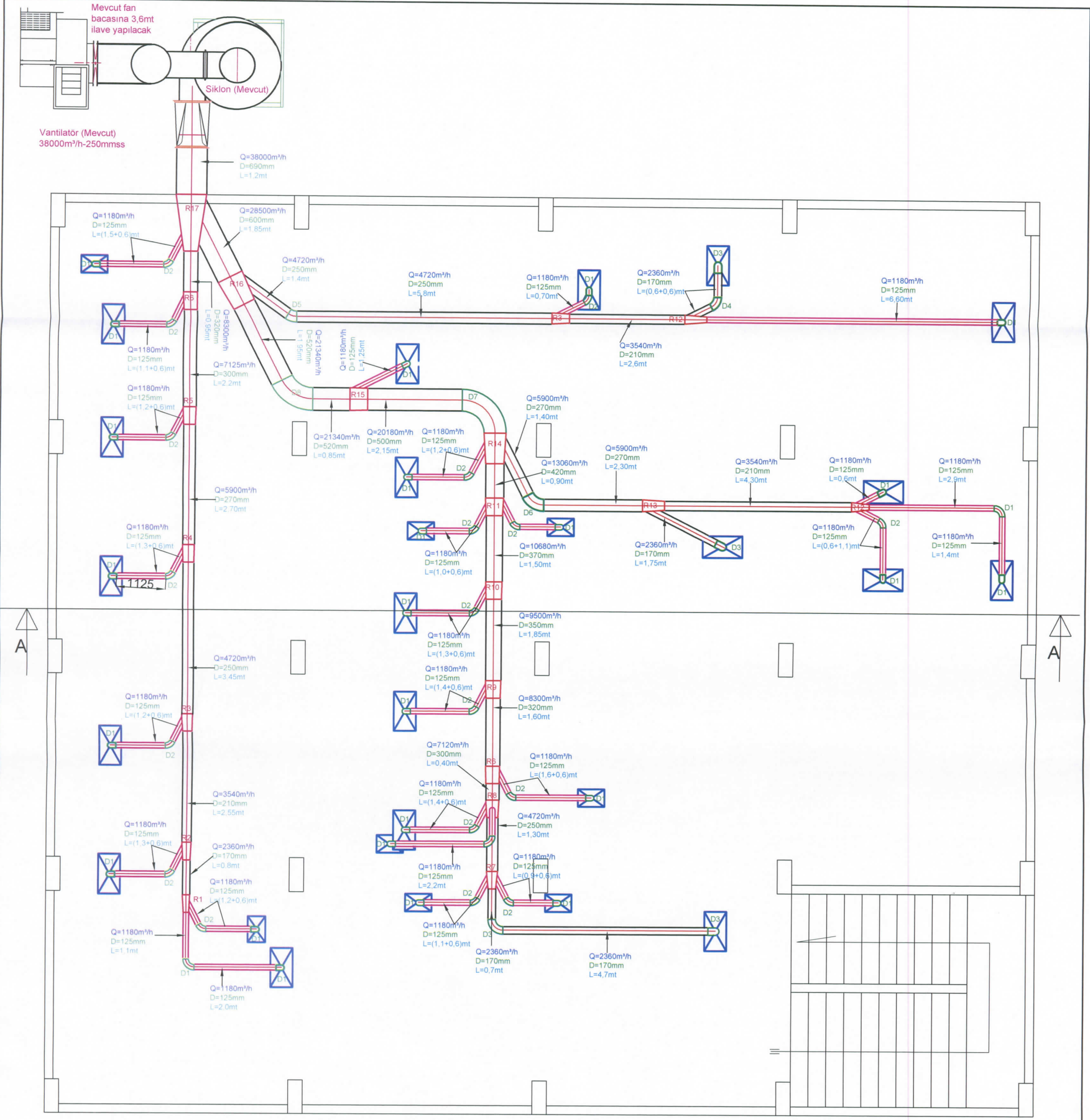

Çizen	Tarih	isim	imza	
Etüt Prj.Md.		Selami COŞKUN		Bayram SEKMEN Makina Dairesi Başkanı
Makina Müd.		Orhan YAVUZ		
Miz.Pln.Müd.		S. EYÜBOĞLU		
ÖLÇEK		KENDİRLİ ÇAY FABRİKASI ELEK KESİT GÖRÜNÜŞÜ		Resim no

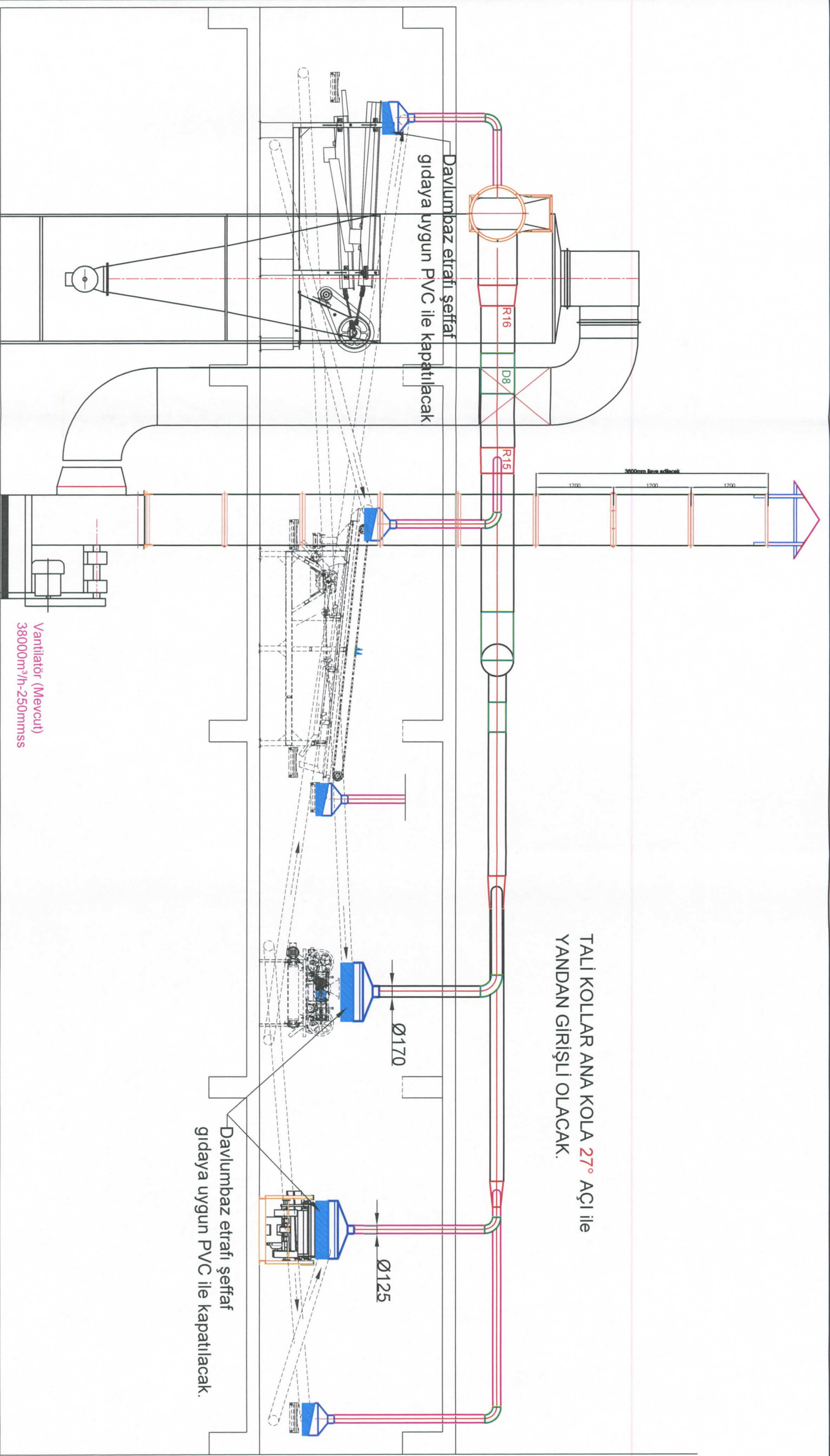

A-A KESİTİ

TALI KOLLAR ANA KOLA 27° AÇI İLE YANDAN GİRİŞLİ OLACAK.

Davlumbaz etrafı şeffaf gıdaya uygun PVC ile kapatılacak.

Vantilatör (Mevcut)
38000m³/h-250mmss



Çizen	Tarih	İsim	İmza	Resim no
Etiit Prj.Md.		Selami COŞKUN		
Makina Müd.		Orhan YAVUZ		
Miz.Pln.Müd.		S. EYÜBOĞLU		
OLÇEK				
KENDİRLİ ÇAY FABRİKASI ELEK KESİTİ GÖRÜNÜŞÜ				
				Bayram SEKMEN Makina Dairesi Başkanı

				boru çapı(Q)	uzunluk(L)(m)
				690mm	1,20m
				600mm	1,90m
				520mm	2,90m
				500mm	2,20m
				420mm	0,90m
				370mm	1,50m
				350mm	1,90m
				320mm	2,60m
				300mm	2,80m
				270mm	6,50m
				250mm	12,0m
				210mm	9,50m
				170mm	9,50m
				125mm	60,0m

Dirsek	Derece	çap(Ø)	Miktar
D1	90°	125mm	30Adet
D2	63°	125mm	22 Adet
D3	90°	170mm	1 Adet
D4	63°	170mm	1 Adet
D5	63°	250mm	1 Adet
D6	63°	270mm	1 Adet
D7	90°	500mm	1 Adet
D8	63°	520mm	1 Adet

NOT:Ø125ve 130"luk DKP BORULARIN SAC KALINLIĞI: 1,5mm

Ø130 ÜSTÜ BORULAR İÇİN DKP SAC KALINLIĞI: 2,0mm

Tarih	Ad Soyad	İmza	Onay
	Selami COŞKUN		
Çizen	Orhan YAVUZ		Bayram SEKMEN Makina Daire Başkanı
Mak. Et.P. Şb.Md.	Selahattin EYÜBOĞLU		
Makina Şb.Müd.			
Ölçek	Parça Adı :		Malzeme
Ağırlık			Resim No
İmalat Adeti			2018

KENDİRLİ ÇAY FABRİKASI
TASNİF TOZ BORU ve DIRSEK İMALATI





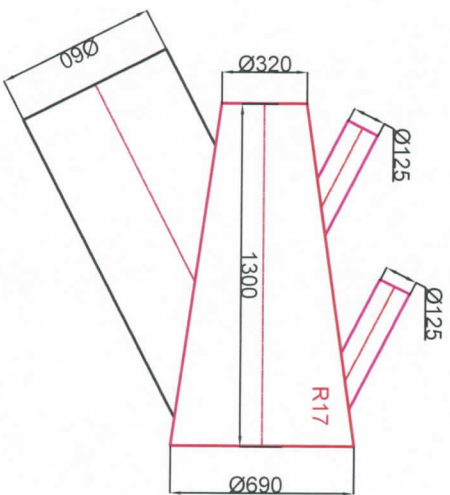
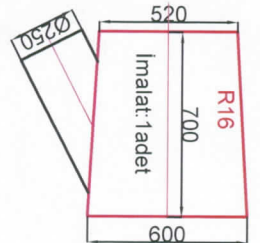
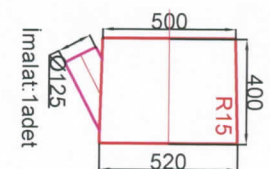
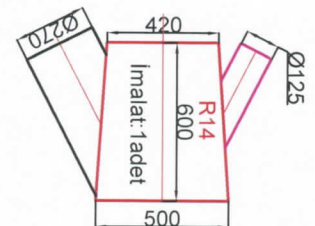
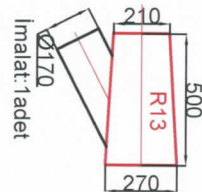
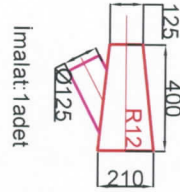
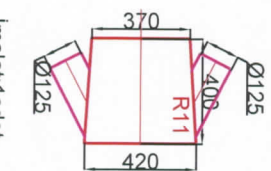
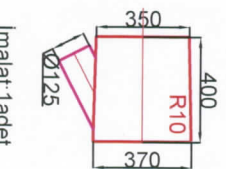
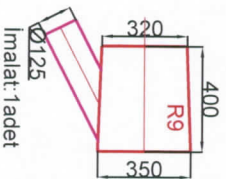
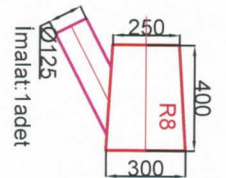
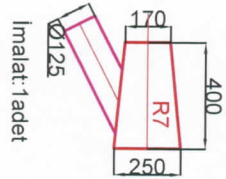
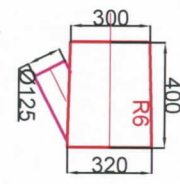
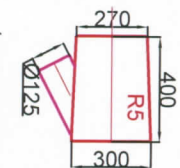
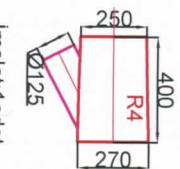
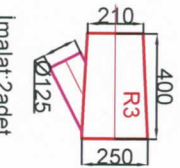
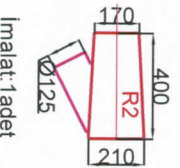
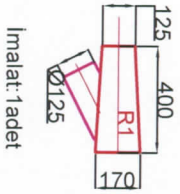

DKP SAC KALINLIĞI:2MM

Çizen	Tarih	Ad Soyad	İmza	Onay
Mak. Et. P. Şp. Md.		Selami COŞKUN		
Makina Şp. Müd.		Orhan YAVUZ		
Ölçek	Parça Adı :	Selahatin EYÜBOĞLU		
Ağırlık	KENDİRLİ ÇAY FABRİKASI			
İmalat Adeti	TASNİF TOZ REDÜKSİYON İMALATI			
	Malzeme	Bayram SEKMEN Makina Daire Başkanı		
	Resim No	2017-11		
	Ürün Kodu			

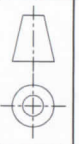

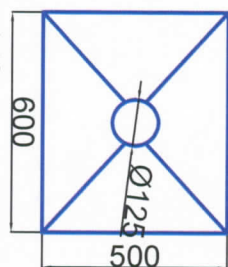
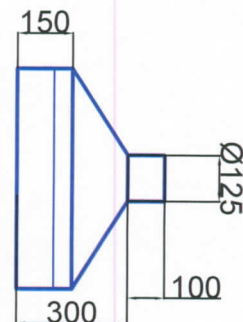
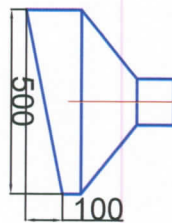

Band Aktarma ve Big Bag
dolun ağı Davlumbazı
imalat: 12 adet

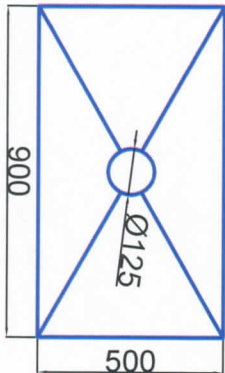
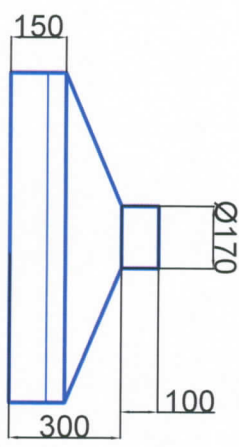
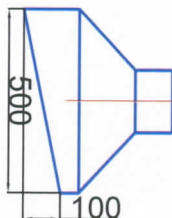
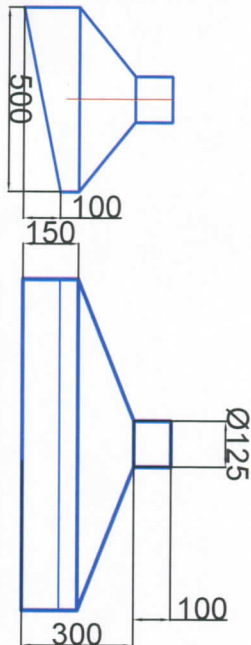

Pakka ve Midilton ve
göp eleği Davlumbazı
imalat: 12 adet

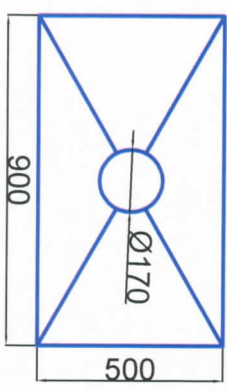

Lif Alıcı Davlumbazı
imalat: 3 adet

NOT:KROM (304)SAC KALINLIĞI
Davlumbaz için :1,5mm

Çizen	Tarih	Ad Soyad	İmza	Onay
Mak.Et.P.Şb.Md.		Selami COŞKUN		
Makina Şb.Müd.		Orhan YAVUZ		Bayram SEKMEN Makina Daire Başkanı
Ölçek	Parça Adı :			
Ağırlık	KENDİRLİ ÇAY FABRİKASI TASNİF TOZ DAVLUMBAZ İMALATI			
İmalat Adeti				
Malzeme				
Ürün Kodu	2017-9			

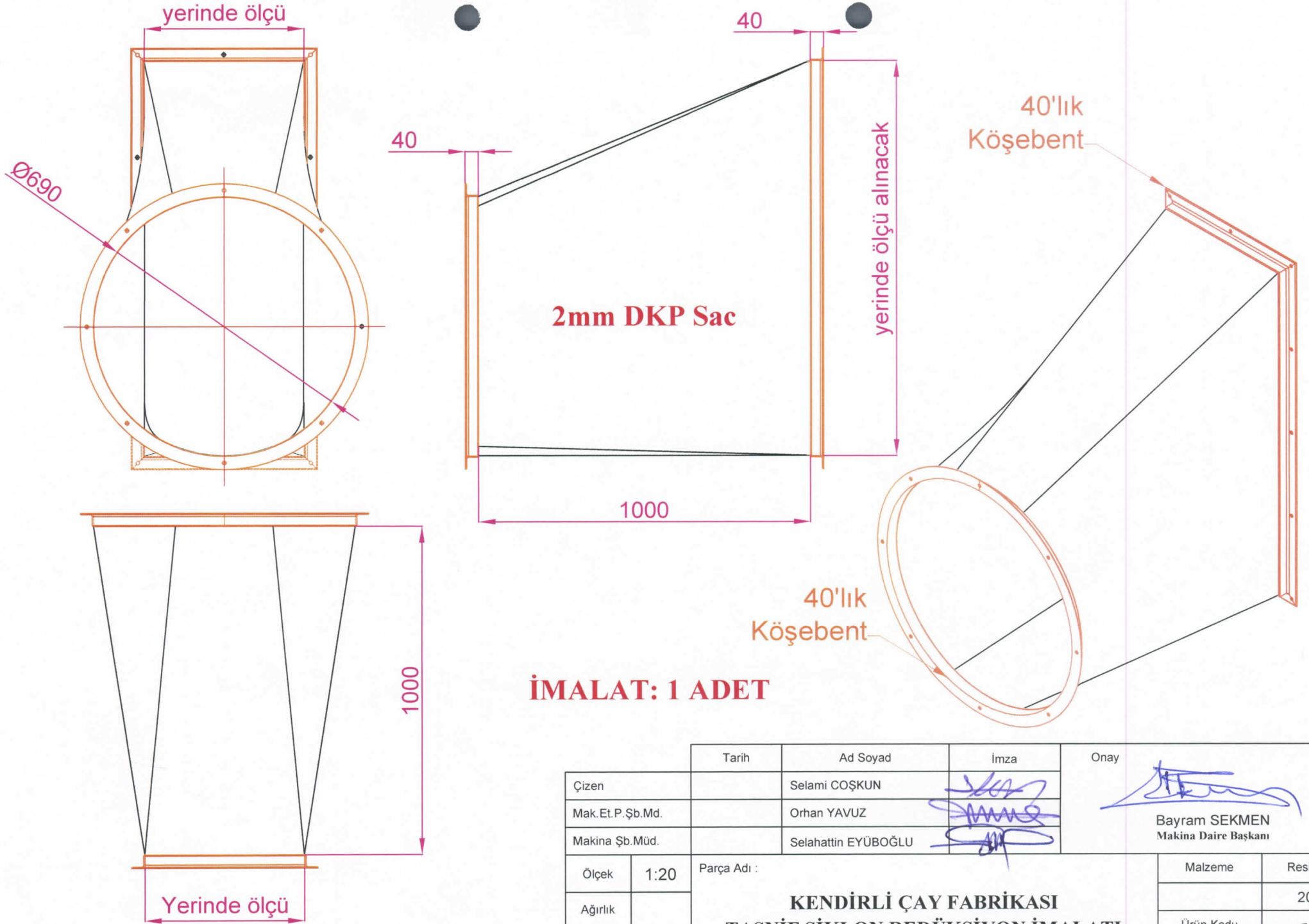

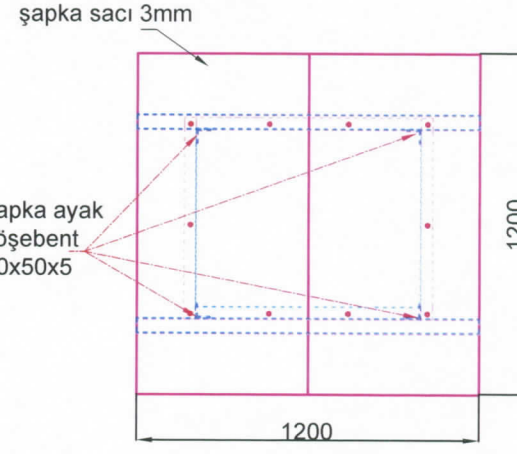
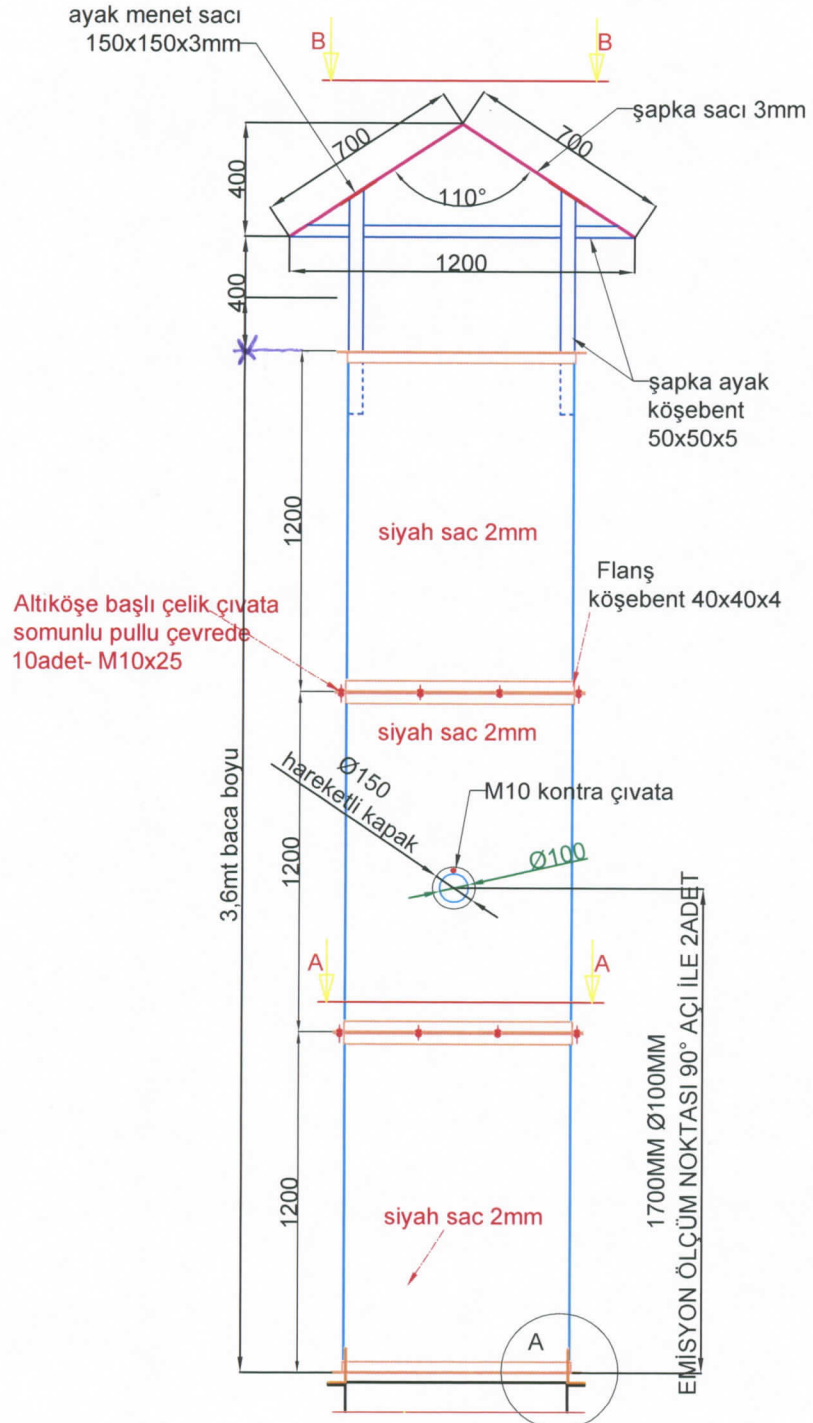

B-B BAKIŞI

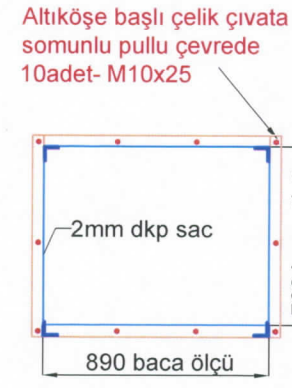

A-A KESİTİ

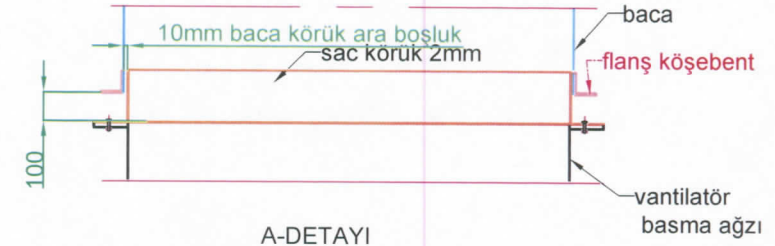

A-DETAYI

3,6 MT BACA İLAVESİ YAPILACAK
ilaveler baca kesit ölçüleri yerinde
alınarak yapılacaktır.

Çizen		Tarih	Ad Soyad	İmza	Onay
Mak.Et.P.Şb.Md.			Selami COŞKUN		 Bayram SEKMEN Makina Daire Başkanı
Makina Şb.Müd.			Orhan YAVUZ		
			Selahattin EYÜBOĞLU		
Ölçek		Parça Adı :			Malzeme
Ağırlık		KENDİRLİ ÇAY FABRİKASI TASNİF TOZ EMME BACA İMALATI			Resim No
İmalat Adeti					Ürün Kodu

